Demystify DSI I/F

Erwan Petillon

HW Systems Solutions

ABSTRACT

The purpose of this Application Note (APN) is to demystify the DSI I/F by presenting different configuration and their impact on the DSI protocol. The document is illustrated by numerous waveforms probe on an OMAP platform.

This APN covers the DSI protocol in video mode (Non-frame buffer display) and in command mode (frame buffer display).

A section dedicated to debugging tips is enumerating different method to measure various parameters and decode LP and HS packets.

However the APN does not contain programming model and complete DSI protocol standard, for more details on programming model refer to the OMAP Technical Reference Manual and the MIPI DSI protocol standard.

Document History

Version	Date	Author	Notes
1.0	November 2012	E. Petillon	First release

Contents

1	MIPI DSI protocol.....	4
1.1	Command mode.....	4
1.2	Video mode.....	4
2	DSI video mode.....	7
2.1	Blanking mode.....	7
2.2	Non-continuous clock mode.....	10
2.3	Interleaving.....	12
3	DSI command mode.....	17
3.1	Tearing Effect (TE) control.....	17
3.1.1	DSI-PHY TE trigger.....	18
3.1.2	CMOS TE line.....	19
4	Tips and debug.....	21
4.1	Basic measurements.....	21
4.2	Basic decoding using an oscilloscope.....	24
4.2.1	LP transfer Decoding using an oscilloscope.....	24
4.2.2	HS transfer Decoding using an oscilloscope.....	25
4.2.3	Determine all clocking and timings of the Display subsystem.....	27
Appendix A. Display Subsystem configuration.....		28
References.....		28

Figures

Figure 1: Video mode - packets definitions.....	5
Figure 2: Non-burst mode Sync pulses.....	5
Figure 3: Non-burst mode Sync event.....	6
Figure 4: Burst mode.....	6
Figure 5: Horizontal blanking of last VACT and vertical blanking.....	7
Figure 6: All blanking done in HS blanking packets.....	8
Figure 7: Single LP transition per frame.....	8
Figure 8: BLANKING_MODE= 0x0.....	9
Figure 9: last lines transmitted before vertical blanking when BLANKING_MODE=0x0.....	9
Figure 10: DDR_CLK_ALWAYS_ON = 0x0 and all Blanking mode set to 0x1.....	10
Figure 11: Zoom on vertical blanking when DDR_CLK_ALWAYS_ON = 0x0 and all Blanking mode set to 0x1.....	11
Figure 12: DDR_CLK_ALWAYS_ON = 0x0 and BLANKING_MODE = 0x0.....	11
Figure 13: DCS NOP command sent in LP during vertical line blanking.....	12
Figure 14: Zoom of DCS NOP command sent in LP during vertical line blanking.....	13
Figure 15: HS NOP DCS command followed by BTA during a vertical line blanking.....	14
Figure 16: Zoom of HS NOP DCS command followed by BTA during a vertical line blanking.....	14
Figure 17: 2 HS DCS command with BTA.....	15
Figure 18: Protocol view of a read request when no error.....	15
Figure 19: Read request perform during vertical line blanking.....	16
Figure 20: Zoom on a Read request perform during vertical line blanking.....	16
Figure 21: Read request exceeding vertical line blanking.....	17
Figure 22: Complete sequence of DSI-PHY TE trigger.....	18
Figure 23: Start of transfer after TE trigger message.....	19

Figure 24: TE trigger message from panel and BTA from panel to Host	19
Figure 25: TE line trigger at 60Hz.....	20
Figure 26: Full frame transfer after TE line trigger	20
Figure 27: Delay between TE trigger and 1st line transfer	21
Figure 28: Frame duration measurement	22
Figure 29: Line duration measurement	22
Figure 30: LP clock measurement	23
Figure 31: HS measurement.....	24
Figure 32: LP data transmission	25
Figure 33: High-Speed Data Transmission.....	26
Figure 34: Decoding of HS packet (HSS sync packet).....	26

Tables

Document History	1
------------------------	---

1 MIPI DSI protocol

Two modes are supported in the MIPI DSI protocol standard, Command mode and Video mode. This section details briefly these modes but for complete details refer to *MIPI Alliance Specification for Display Serial Interface Version 1.02.00*.

1.1 Command mode

Command mode is used when the panel integrates a display controller and a frame buffer (FB). Transfer usually takes place in a form of a command followed by data pixels and/or parameters. The Host can write to and read from the panel registers and FB.

The start of the frame transfer can be controlled by the panel using the Tearing Effect (TE) either by an external pin, TE line, or via the DSI lanes using the TE trigger message.

As data could be transmitted from panel to host, the host I/F have a bidirectional lane.

1.2 Video mode

During a Video mode transfer, pixel data are transferred from Host to panel in real-time. Panels may include simple timing controller and partial FB.

Within the video mode, 3 different sub-modes are present:

- **Non-burst Mode Sync pulses:** In this mode, based on the various synchronization packets sent, it is possible to reconstruct, time-accurate, the pixel streaming and also the synchronization timings as defined in the DPI standard. Refer to Figure 2.
- **Non-burst Mode Sync event:** It is similar to Non-burst Mode Sync pulses, except that the accurate reconstruction of sync timings is not possible. Only single start sync event packets are sent. Refer to Figure 3.
- **Burst mode:** The DSI speed link is increased to the maximum speed supported by the panel while maintaining same horizontal timings. RGB pixel packets are time-compressed. In this case it leaves more time for a LP transition or for other transmission on the link during the scan line. Refer to Figure 4.

To enable such synchronization, different packets are sent to panels to indicate start and end of porch. Figure 1 presents all packets used for the different sub-video mode.

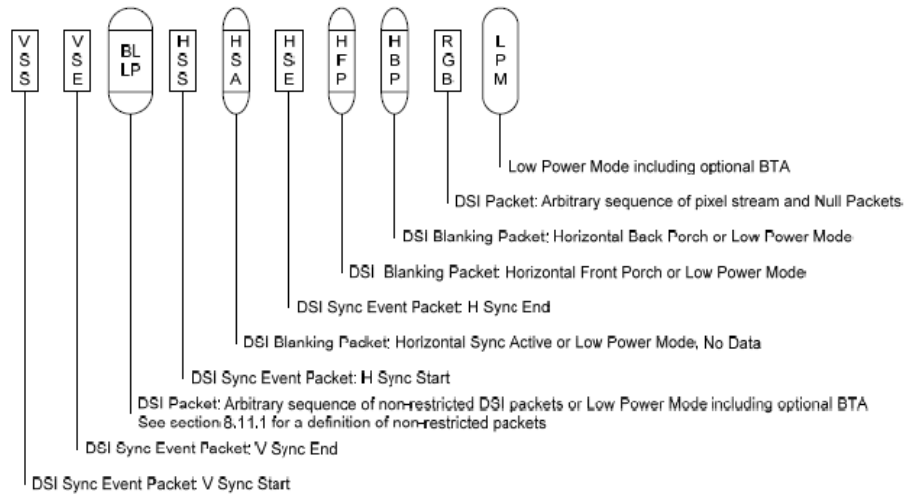

Figure 1: Video mode - packets definitions

In Figure 2 to Figure 4, BLLP indicates blanking (BL) or low power (LP) periods. During these periods, the following could happen on the DSI link:

- Host and panel remain in Idle Mode. Lanes are in LP-11 state.
- Host transmits one or more non-video packets to the peripheral using Escape mode (low-power Tx).
- Host transmits one or more non-video packets to the peripheral using HS Mode, for example transmit blanking packets or DCS commands.
- If the previous processor-to-peripheral transmission ended with BTA, panel transmits one or more packets to the host processor using Escape Mode.
- Host Transmit one or more packets to a different peripheral using a different virtual Channel ID (VC).

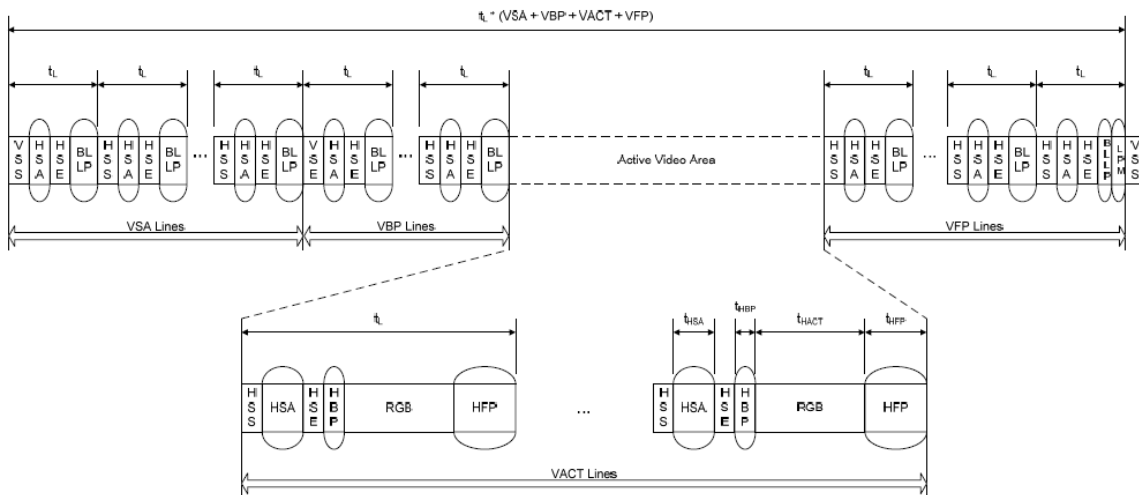

Figure 2: Non-burst mode Sync pulses

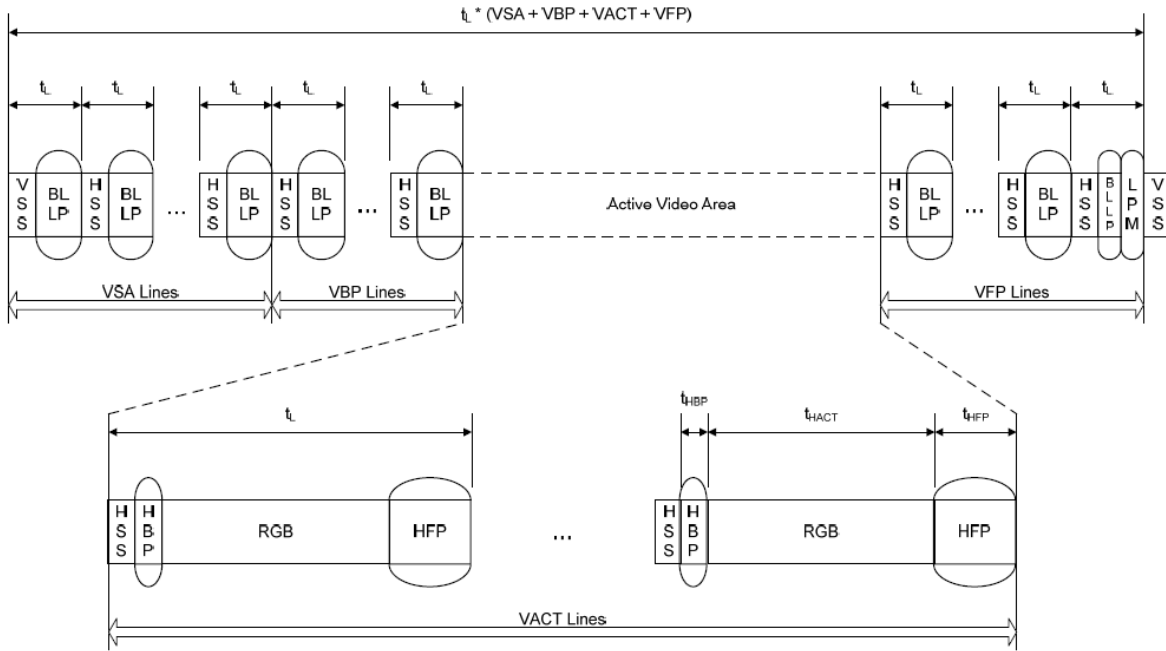

Figure 3: Non-burst mode Sync event

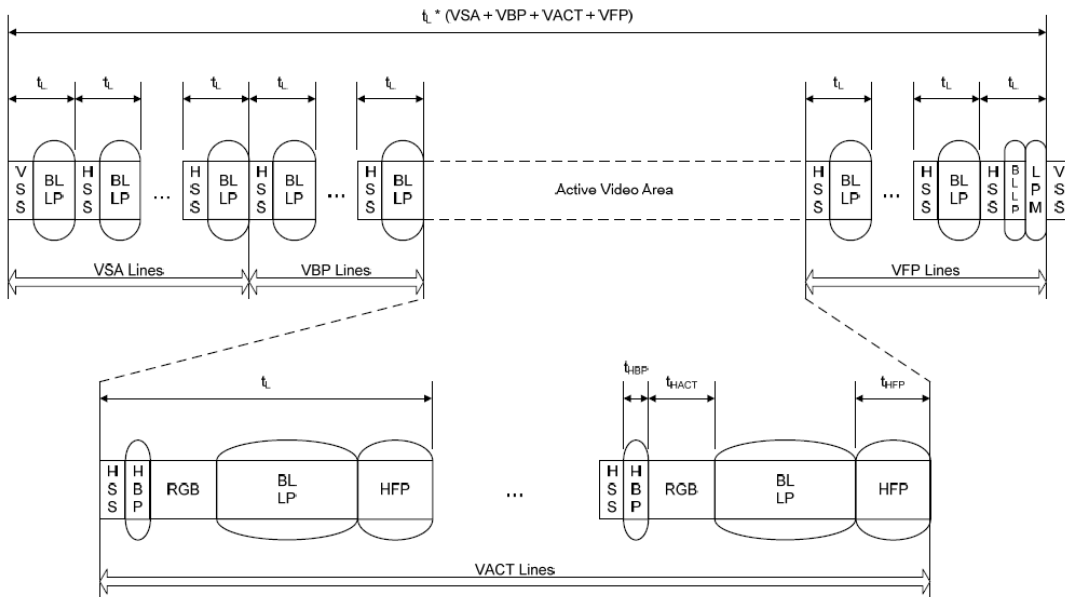

Figure 4: Burst mode

2 DSI video mode

2.1 Blanking mode.

As explained in section 1.2, during periods of non-transmission of pixel stream (BLLP periods), the DSI link could be in 2 states, low power or HS transmission of blanking packets. OMAP allows user to define the states to be adopted for each horizontal porches and overall vertical porch by configuring HSA_BLANKING_MODE, HBP_BLANKING_MODE, HFP_BLANKING_MODE and BLANKING_MODE bits in DSI_CTRL [23:20].

When configuring LPS during blanking, it is the user responsibility to verify that enough time is available to transit from HS to LP and back to HS during the blanking period, specifically for the horizontal period as it is a short period. No HW check is done in the DSI subsystem.

Figure 5 represents the 2 last VACT before a vertical blanking starts. HSS packet is preceded by a period of HFP blanking and then followed by the HBP blanking.

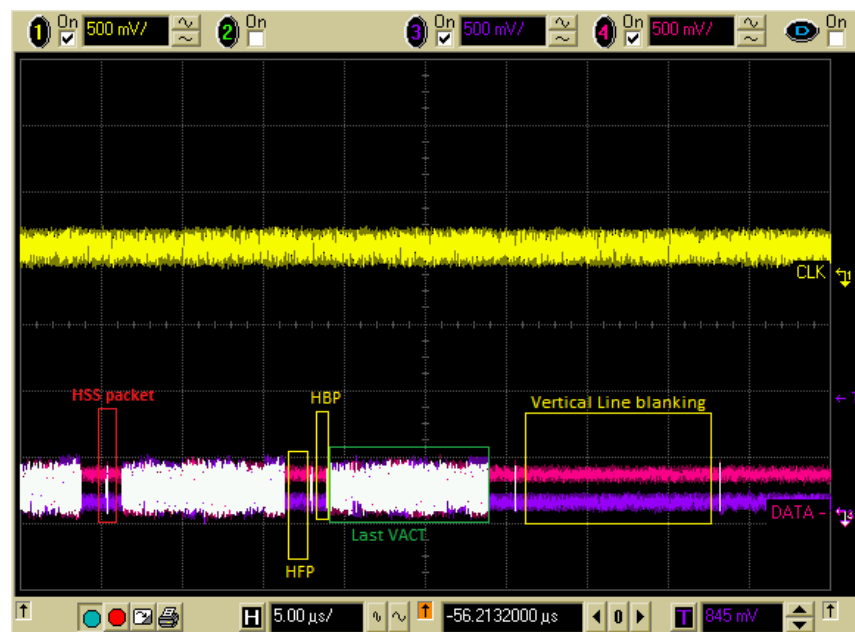

Figure 5: Horizontal blanking of last VACT and vertical blanking

Figure 6 shows a setting with all blanking mode done with blanking packets in HS transmission, all blanking modes are set to default values 0x1. As mentioned in MIPI DSI standard, at least once per frame, OMAP drives the data lanes to LP state. In this configuration, LP transition is done every 16.6ms (60 FPS).

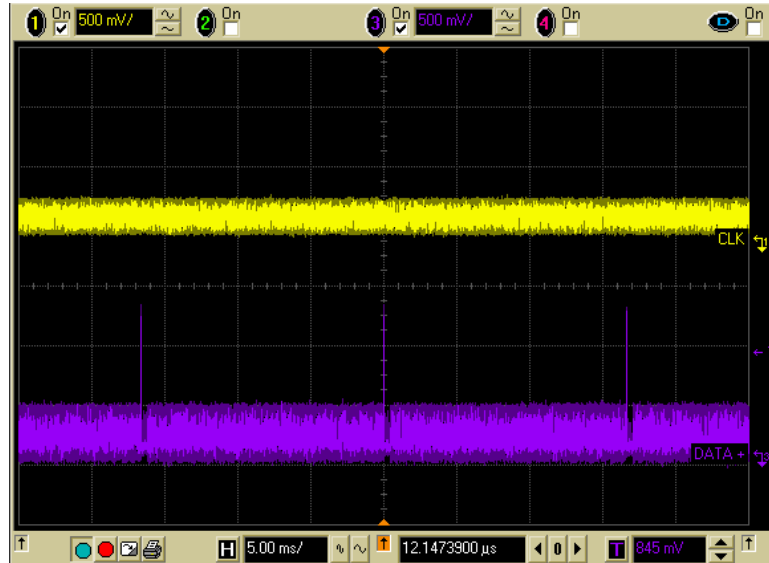

Figure 6: All blanking done in HS blanking packets.

Figure 7 represents a zoom of the vertical blanking period when all blanking mode are set to 0x1. The single LP transition will occur at the first VSA line blanking during vertical blanking. The HSS sync packets followed by the long blanking packets (only 0s) are clearly identified.

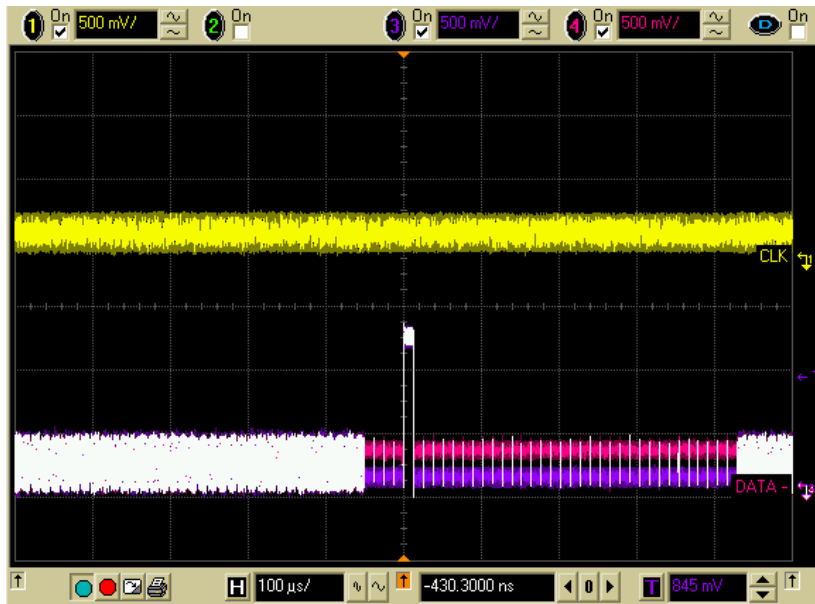

Figure 7: Single LP transition per frame

Figure 8 shows a sync event configuration where BLANKING_MODE (vertical blanking) is set to 0x0. In this configuration, data lanes transit into LP state during blanking. HSS packets are sent at every beginning lines blanking. The total number of lines blanking set in DSI_VM_TIMING2 (VSA+VFP+VBP) can be counted.

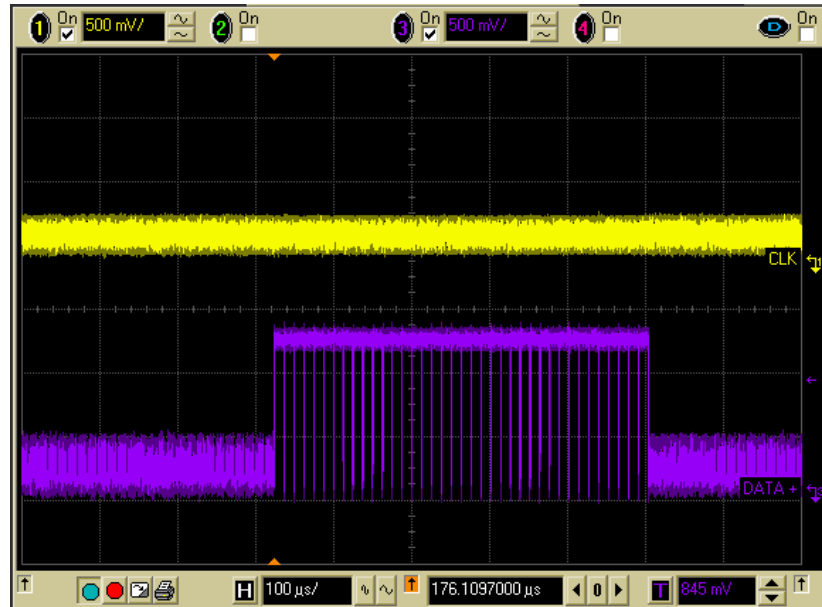

Figure 8: BLANKING_MODE= 0x0

Figure 9 represent the lasts VACT lines transmitted before starting the vertical blanking in LP.

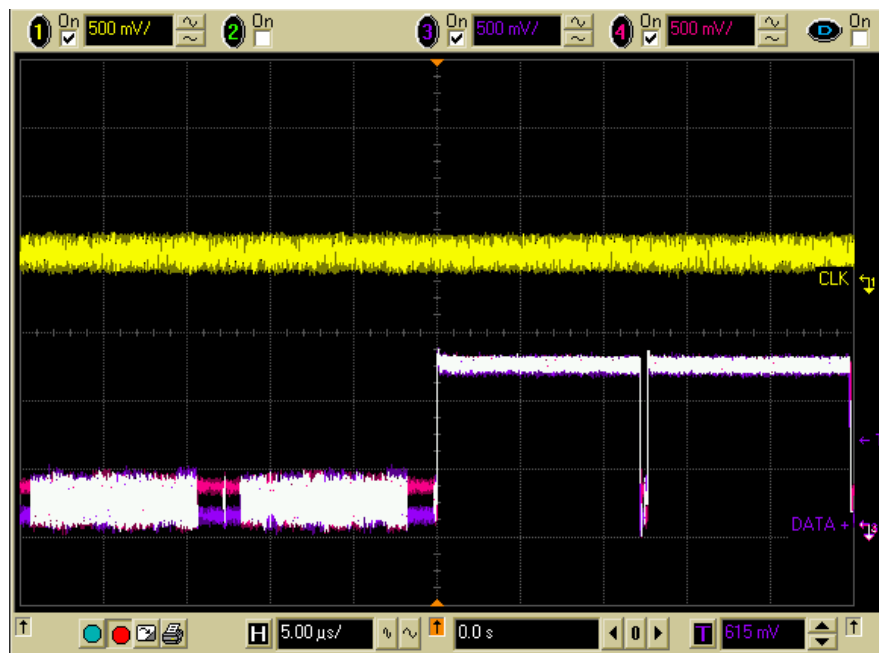

Figure 9: last lines transmitted before vertical blanking when BLANKING_MODE=0x0

2.2 Non-continuous clock mode.

As mention in MIPI Alliance Specification for Display Serial Interface Version 1.02.00 “All DSI transmitters and receivers shall support continuous clock behavior on the Clock Lane, and optionally may support non-continuous clock behavior. A DSI host processor shall support continuous clock for systems that require it, as well as having the capability of shutting down the serial clock to reduce power.”

Figure 8 and Figure 9 show a continuous clock, not stopped even if data lanes transit in LP. In this configuration, DDR_CLK_ALWAYS_ON bitfield in DSI_CLK_CTRL[13] is set to 0x1.

OMAP supports non-continuous clock by setting to 0x0 the bitfield DDR_CLK_ALWAYS_ON in DSI_CLK_CTRL[13]. This setting allows the DDR_CLK to be cut when no HS transmission is needed. In a video mode configuration with all blanking mode set to 0x1, the DDR_CLK will be cut at least once per frame as shown in Figure 10 and Figure 11.

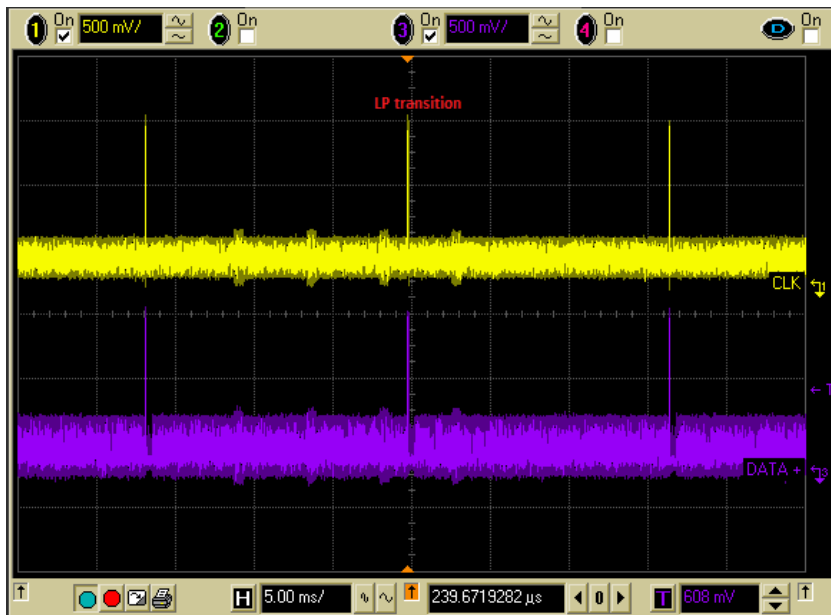

Figure 10: DDR_CLK_ALWAYS_ON = 0x0 and all Blanking mode set to 0x1

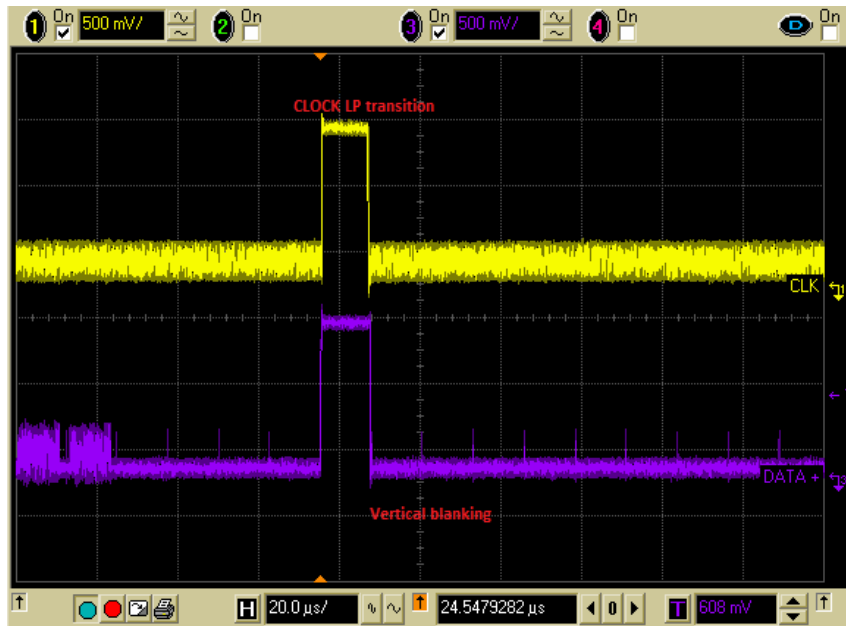

Figure 11: Zoom on vertical blanking when `DDR_CLK_ALWAYS_ON = 0x0` and all Blanking mode set to `0x1`

However, extra `DDR_CLK LP11` state can be achieved if the vertical and horizontal blanking mode are set to `LPS`, as shown in Figure 12, for more details on blanking mode refer to section 2.1.



Figure 12: `DDR_CLK_ALWAYS_ON = 0x0` and `BLANKING_MODE = 0x0`

It is the user responsibility to verify that enough time is available to transition from `HS` to `LP` back to `HS` for both data and clock lanes.

2.3 Interleaving.

It is possible to interleave DCS write and/or read command, BTA during the blanking period using a different VC than the video one (usually VC0). The minimum interleaving period is one line blanking as the data lanes will transit at least once per frame in LP. To increase the interleaving periods, user should set `BLANKING_MODE` to 0x0. Interleaving during horizontal periods is not recommended as period is short. In the case LP transition is possible during horizontal periods and interleaving is considered for the vertical period then it is necessary to lock interleaving during the horizontal period, the user should set `HSA_HS_INTERLEAVING`, `HFP_HS_INTERLEAVING` and `HBP_HS_INTERLEAVING` `DSI_VM_TIMING4[23:0]`, `HSA_LP_INTERLEAVING`, `HFP_LP_INTERLEAVING` and `HBP_LP_INTERLEAVING` `DSI_VM_TIMING5[23:0]` to 0x0.

To control the duration of interleaving, the user can limit the number of packet sent in LP or HS during a vertical blanking period by setting `BL_HS_INTERLEAVING` and/or `BL_LP_INTERLEAVING` `DSI_VM_TIMING6[31:0]`.

The next figures show a NOP DCS command sent, in LP or HS, interleaved into the vertical blanking. The write into the VC1 TX FIFO does not occur at a specific time, meaning the packet is sent on the next line blanking available.

Figure 13 shows a DCS NOP command interleave during a LP vertical blanking.

As shown in Figure 14, once the HSS packet is sent DSI lanes transit into LP11 and a Low Power Data Transmission (LPDT) command is sent then followed by the short packet NOP DCS command.

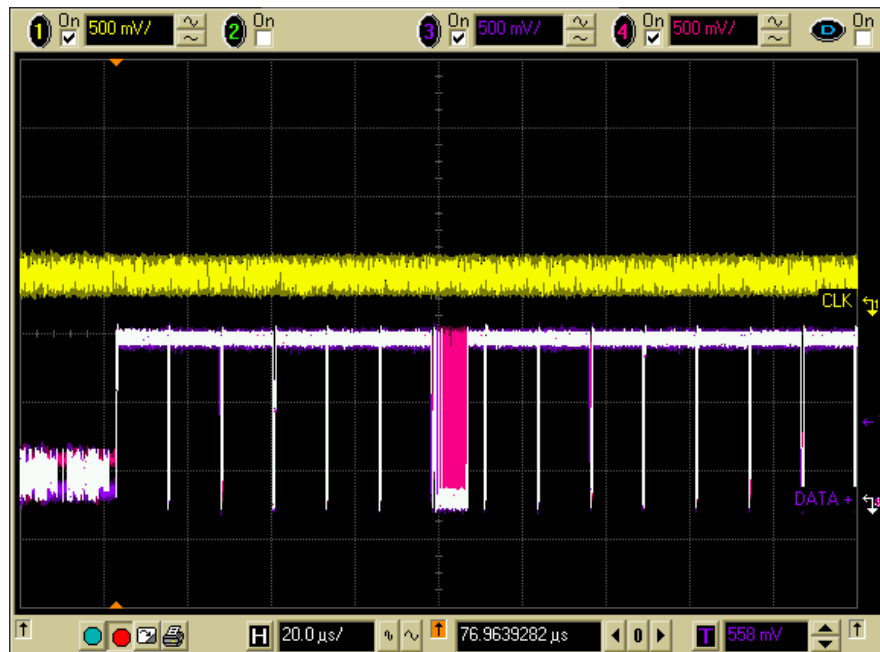

Figure 13: DCS NOP command sent in LP during vertical line blanking

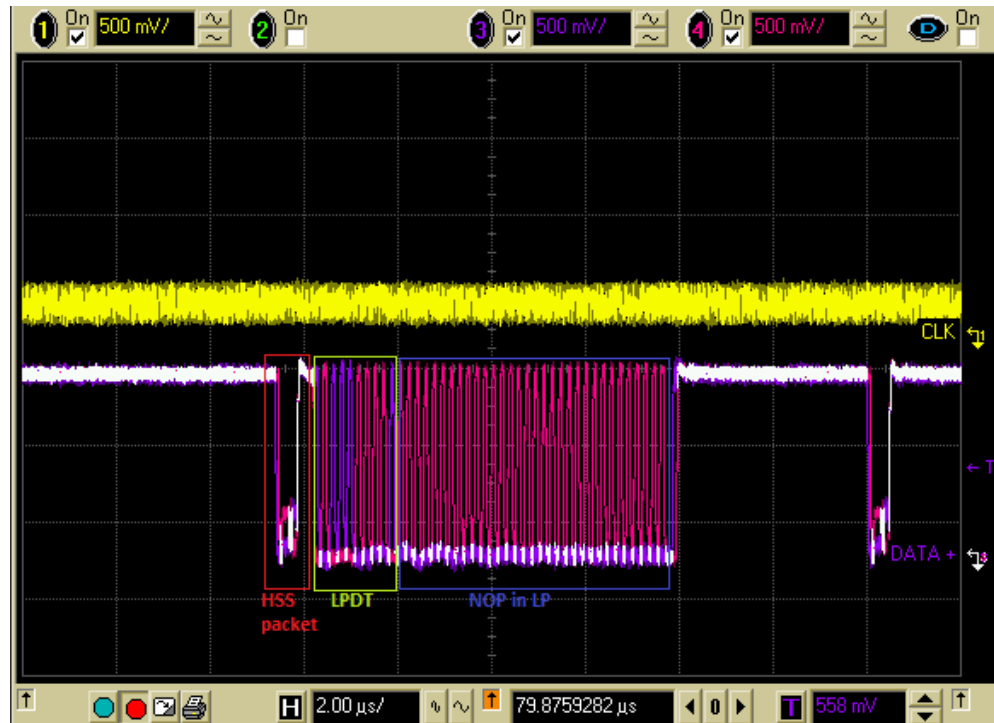

Figure 14: Zoom of DCS NOP command sent in LP during vertical line blanking

Figure 15 demonstrates a NOP DCS command sent in HS interleaved followed by a BTA in the LP vertical blanking. OMAP checks the presence of packets in the TX FIFO at the beginning of the blanking period, this results in NOP DCS command sent back to back with the HSS sync packet. There is no transition to LP between the 2 packets.

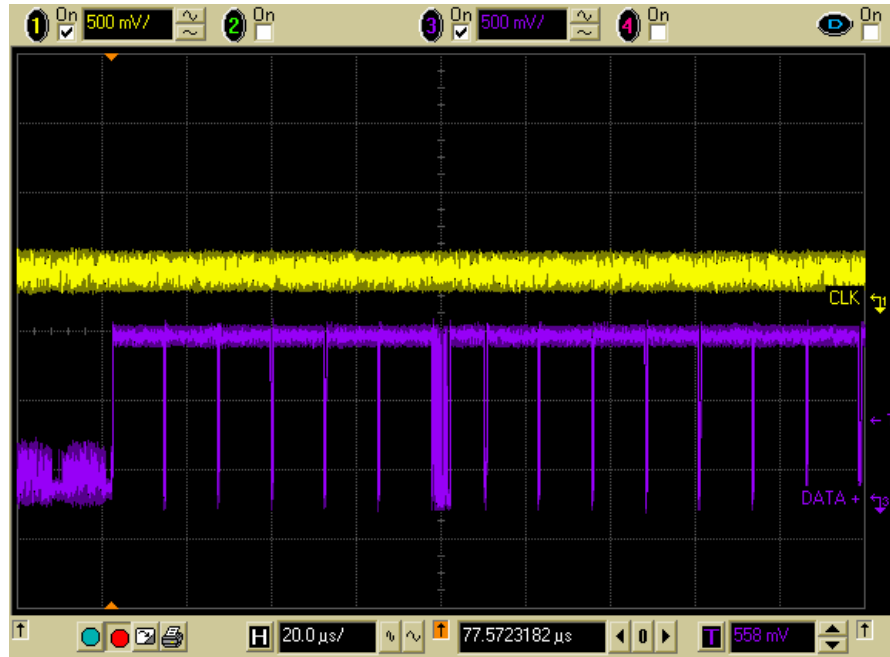

Figure 15: HS NOP DCS command followed by BTA during a vertical line blanking

Once DCS NOP packet is sent a BTA is done to obtain an ACK message from the panel. Following the ACK trigger, the panel returns DSI link to host by a BTA as shown in Figure 16.

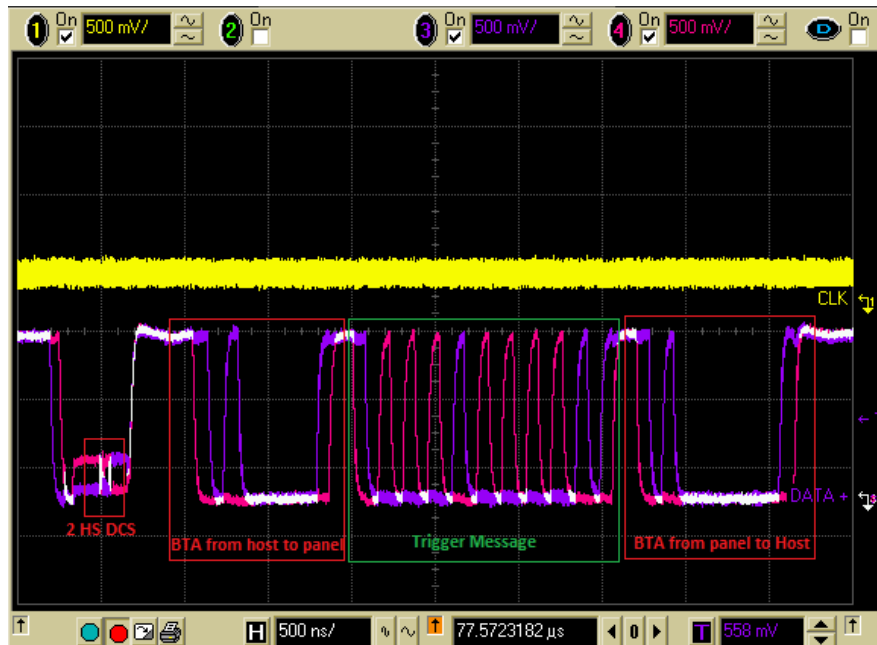

Figure 16: Zoom of HS NOP DCS command followed by BTA during a vertical line blanking

A BTA will end the transmission from host to panel during the current line blanking, meaning no other packets will be sent on DSI link after the BTA until the next line blanking starts, even if time is available in the current blanking. Only ACK trigger or read packet from panel to host could happen after the BTA. Figure 17 represents 2 HS commands wrote back to back in the TX FIFO followed automatically by a BTA once sent (BTA_SHORT_EN bit DSI_VC_CTRL_i[2]set to 0x1).

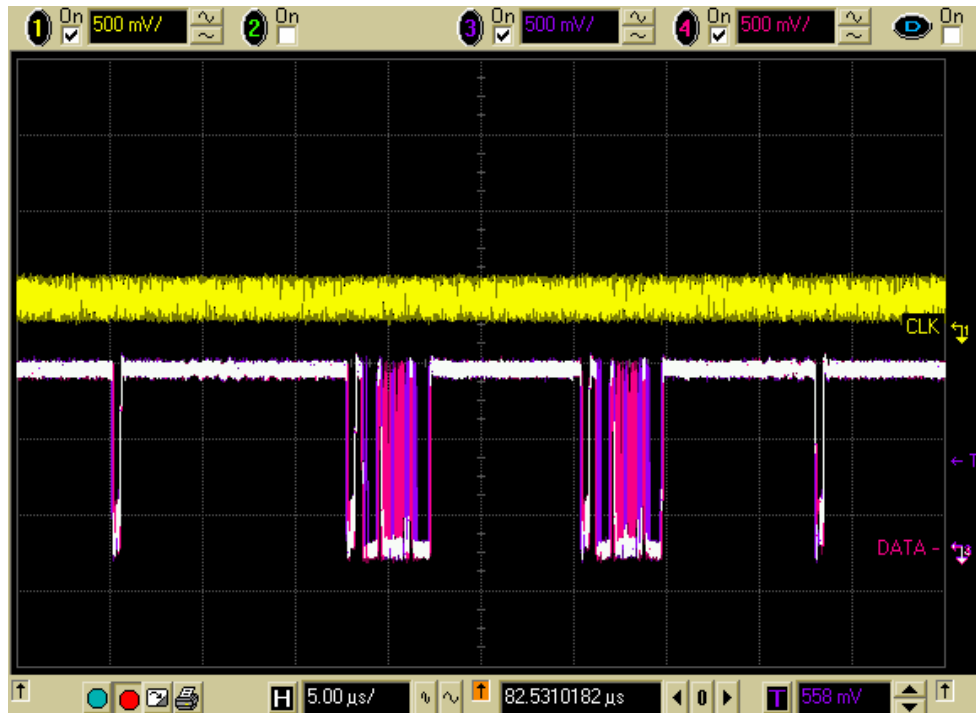

Figure 17: 2 HS DCS command with BTA

When performing a DCS read on the panel, It is the user responsibility to ensure that there is sufficient time to sent the DCS read command (HS or LP), perform a BTA, receive short or long packet from panel (LP only) and restore the DSI link to host by a final BTA within the same line blanking. The overall protocol when performing a read request on the panel is resumed in Figure 18.

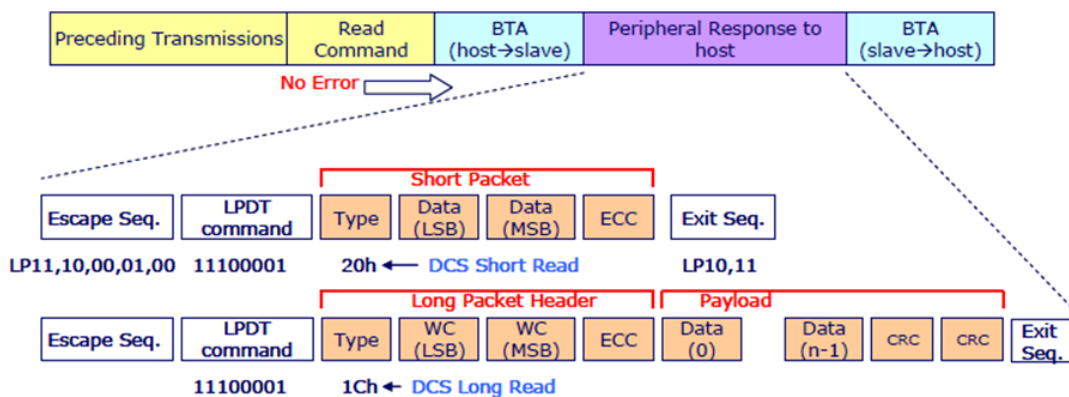

Figure 18: Protocol view of a read request when no error

Figure 19 and Figure 20 illustrate a working read with a DCS short read as feedback from panel.

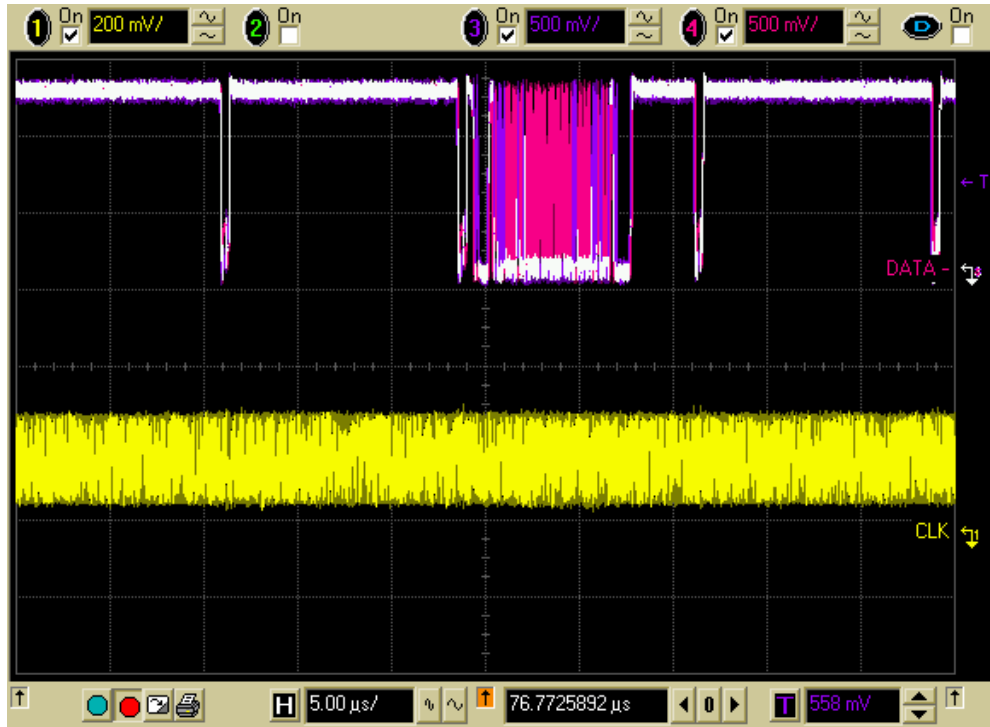

Figure 19: Read request perform during vertical line blanking

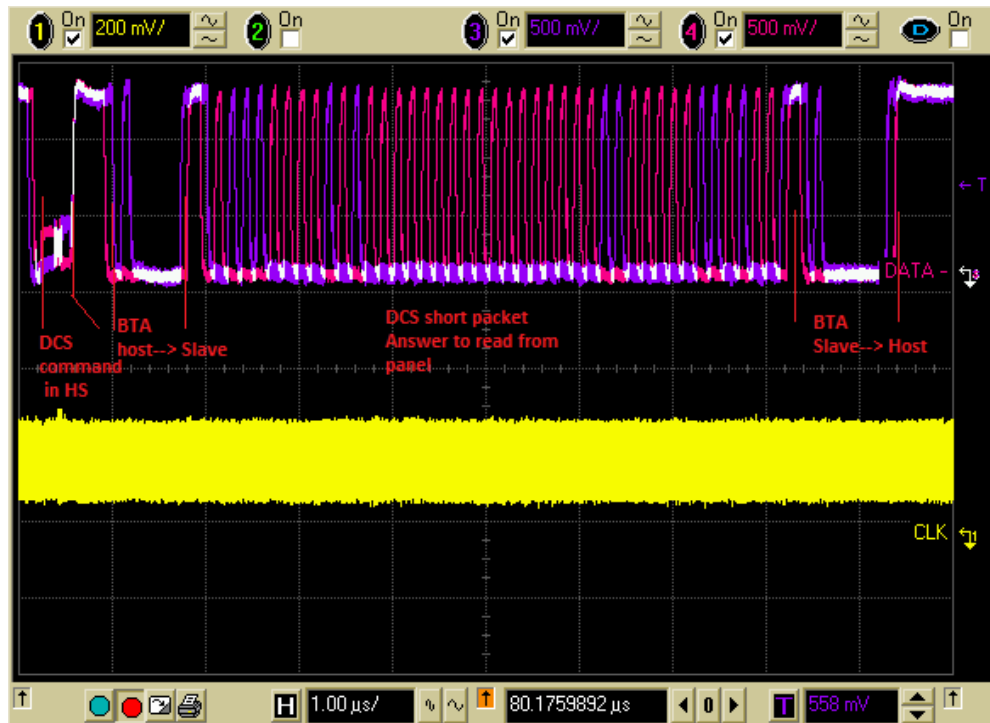

Figure 20: Zoom on a Read request perform during vertical line blanking

Figure 21 shows a configuration where Host send in LP a read request on the ROM panel and data return from panel is a long packet. This overall read request exceeds the duration of a line blanking (approx 12.5us) causing the override of the next HSS sync packet. OMAP recovers this misalignment however this configuration is violating the MIPI DSI standard and could cause a lost of synchronization on panel side. It is the user responsibility to ensure that there is sufficient time to perform the read request within a line blanking, if not possible then the read access should be perform with video mode disable.

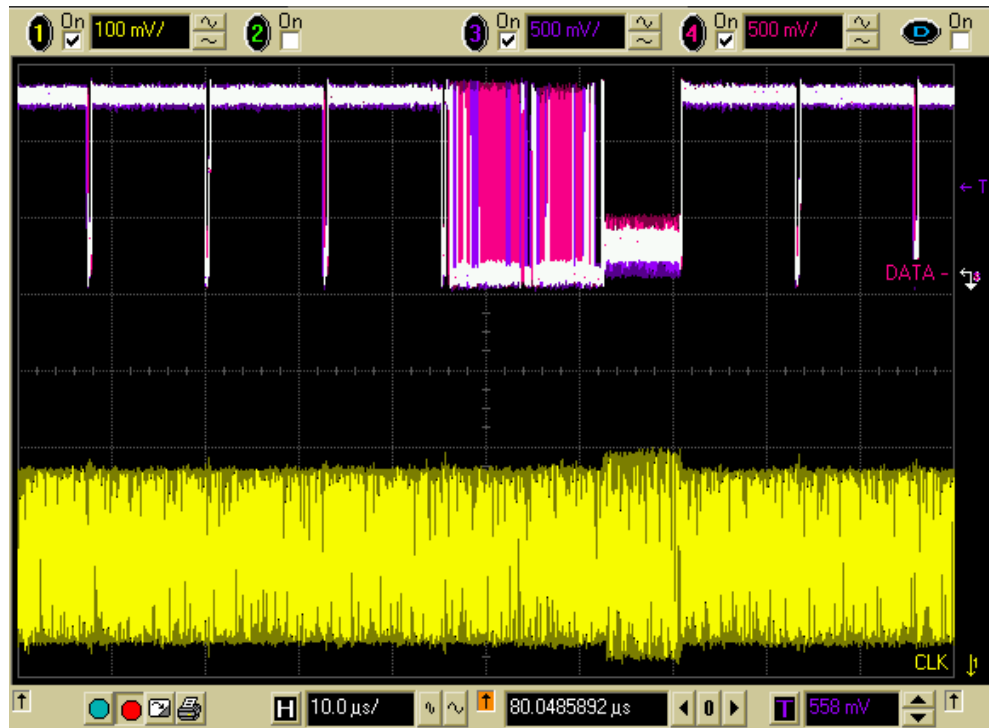

Figure 21: Read request exceeding vertical line blanking

3 DSI command mode

3.1 Tearing Effect (TE) control

A command mode display has its own timing controller and memory frame buffer. In order to avoid tearing effect it is needed to notify the host of timing events on the panel. The sending of the pixel data in a command mode can be achieved in 3 different manners:

- Automatic mode: The SW starts the transfer when it is needed by setting to 0x1 the TE_START bit in DSI_VC_TE_i[31](TE_EN should be set to 0x0 in DSI_VC_TE_i[30]). TE_START is HW cleared once transfer is finished. It lets SW start the transfer manually based on application events or based on the TE trigger interrupt (TE_TRIGGER_IRQ). If no synchronization is done, then some tearing effect could appear.

- DSI PHY TE trigger: MIPI DSI standard defines a TE trigger message which is conveying from panel to host through the DSI link. Once the trigger is received the pixel data is automatically started.
- CMOS TE line: This synchronization method is not part of the MIPI DSI standard but it is supported by OMAP. The pixel data transfer will start automatically when the pre-defined event will happen on the TE CMOS line. 2 TE CMOS lines are available on OMAP. One TE CMOS line can start a transfer onto 1 or more VC channels.

For a complete description of the programming sequence of each mode, please refer to the OMAP Technical Reference Manual.

3.1.1 DSI-PHY TE trigger

At host side, to enable DSI-PHY TE trigger, DSI_VC_TE_i[30] TE_EN bit is set and DSI_VC_TE_i[29] TE_LINE bit is reset. In this configuration the hardware must use the TE PHY trigger to start the transfer of the data from the related VC. TE_EN is reset when all the data are sent to the peripheral. Other parameters need to be configured before trigger message occurs like size of packet, headers, all details are available in the OMAP Technical Reference Manual.

On the panel side, set_tear_on and set_tear_scanline DCS commands are sent to the panel to enable DSI-PHY TE trigger.

At protocol level once configuration is done, the Host should give the bus possession to the panel in order to perform the TE-reporting. This is done by performing a BTA, refer to Figure 22. After the sending of the TE trigger, the panel returns bus possession to the Host to convey the pixel data, refer to Figure 23 and Figure 24.

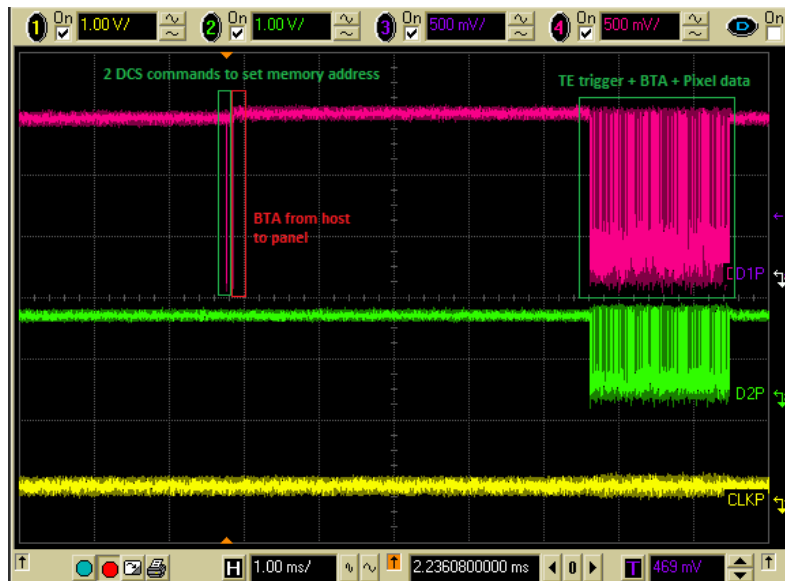

Figure 22: Complete sequence of DSI-PHY TE trigger

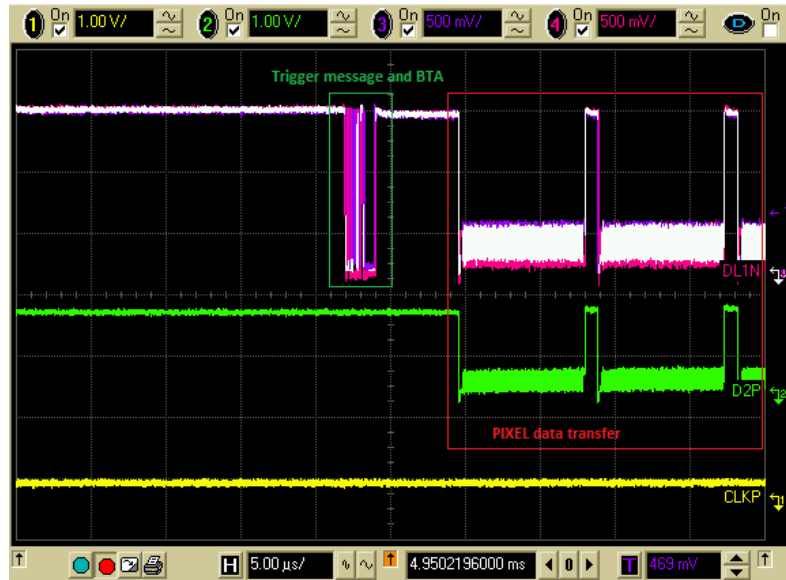

Figure 23: Start of transfer after TE trigger message

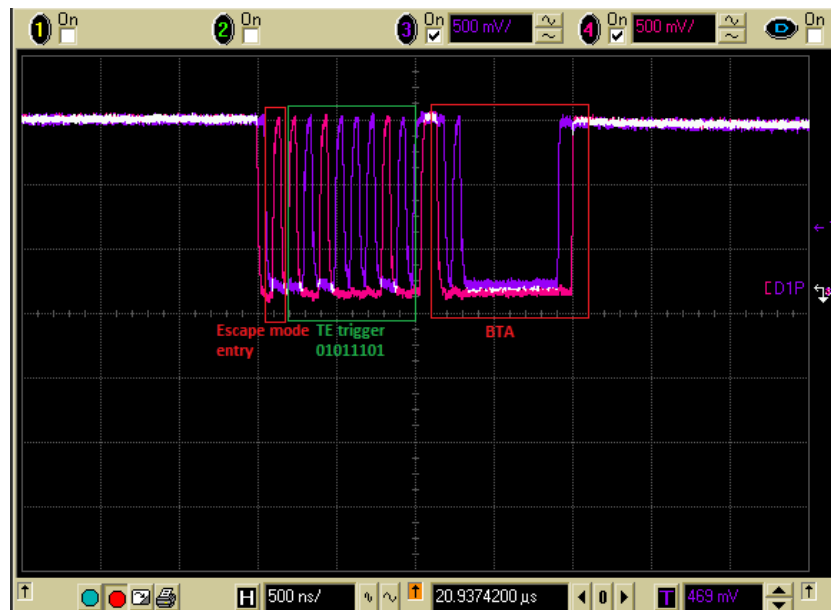

Figure 24: TE trigger message from panel and BTA from panel to Host

3.1.2 CMOS TE line

This mode is not part of the MIPI DSI standard and available on OMAP.

At host side, DSI_VC_TE_i[31:30] TE_EN and TE_LINE bit are set to enable CMOS TE line. Then based on the feature available on the panel, it is possible to start a transfer on a vertical synchronization event or on a number of horizontal synchronization event using DSI_TE_VSYNC_WIDTH_j, DSI_TE_HSYNC_WIDTH_j, and DSI_TE_HSYNC_NUMBER_j registers, for more details refer to the OMAP Technical Reference Manual.

At the panel side, depending on the type of feature available, SW should enable the TE line and configure the type of event generated on this TE line (vertical or horizontal synchronization event) by sending DCS command as stipulated in the panel specification.

Figure 25 illustrates a CMOS TE line configuration. Panel is configured to generate a positive pulse on each vertical synchronization and host is set to start the transfer on it. Frame rate is approximately 60 Hz (16ms) and driven by the panel.



Figure 25: TE line trigger at 60Hz

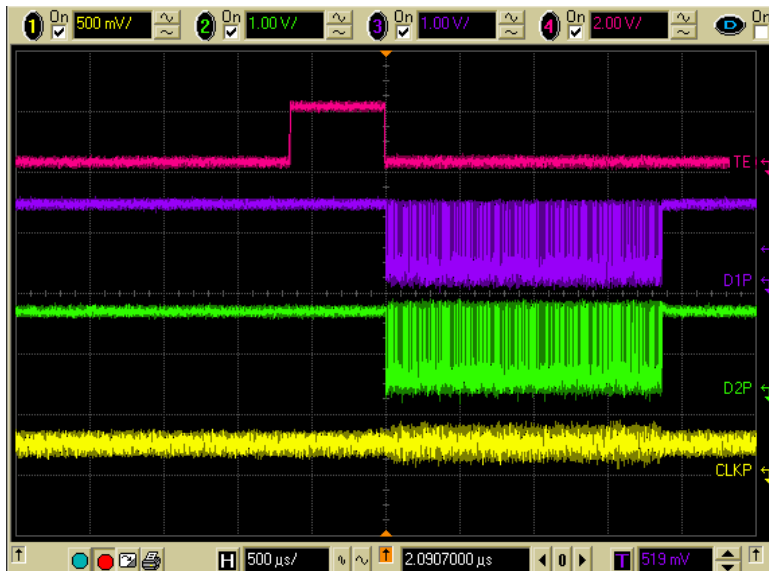

Figure 26: Full frame transfer after TE line trigger

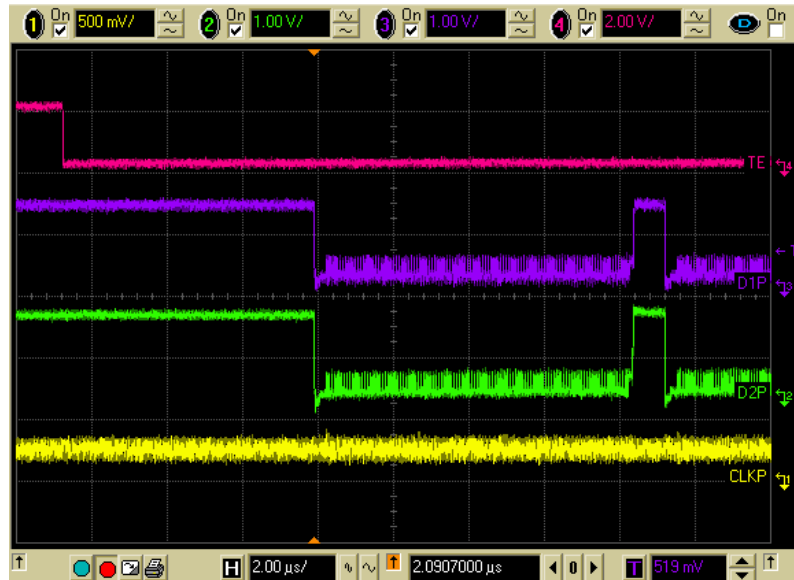

Figure 27: Delay between TE trigger and 1st line transfer

4 Tips and debug

4.1 Basic measurements

- Frame rate (FPS) or frame duration (Fd): To measure exact frame rate on a DSI video mode panel, you must measure the duration Fd between 2 vertical blanking period as shown in

$$FPS = \frac{1}{Fd}$$

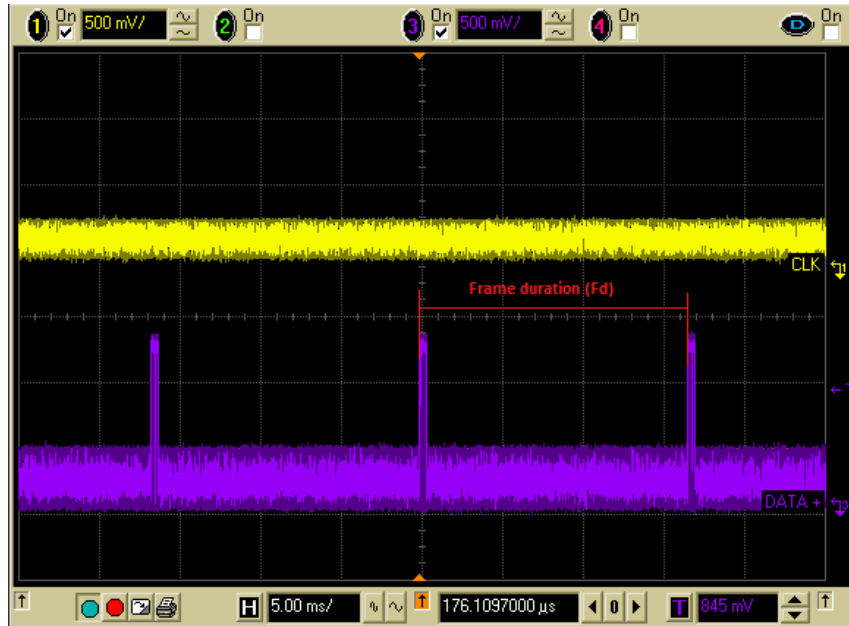

Figure 28: Frame duration measurement

- Line duration (TL): To measure a line duration, 2 options are available:
 - Measure the duration of an active line (VACT) as shown in (1) of Figure 29.
 - Measure the duration of line blanking period during vertical blanking as shown in (2) of Figure 29.

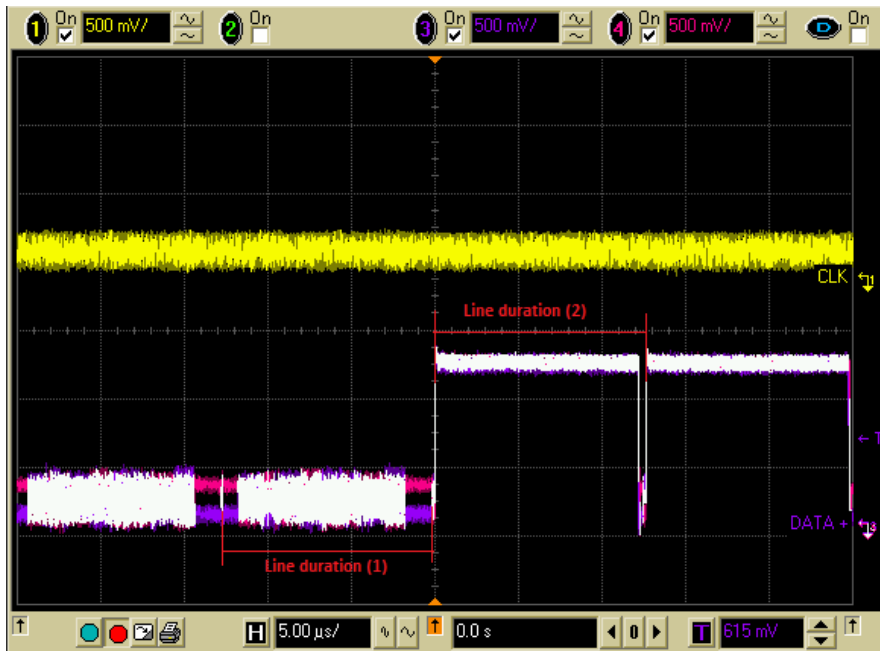

Figure 29: Line duration measurement

- LP clock (LP CLK): The LP clock can be reconstructed by doing an EXOR of the Dp and Dn. To measure it you will need a LP period either by performing a BTA for trigger message or by sending a DCS command in LP. Both Dp and Dn signal are superposed to reconstruct the clock as shown Figure 30. Figure 30 is a zoom of a LPDT between Host and Panel.

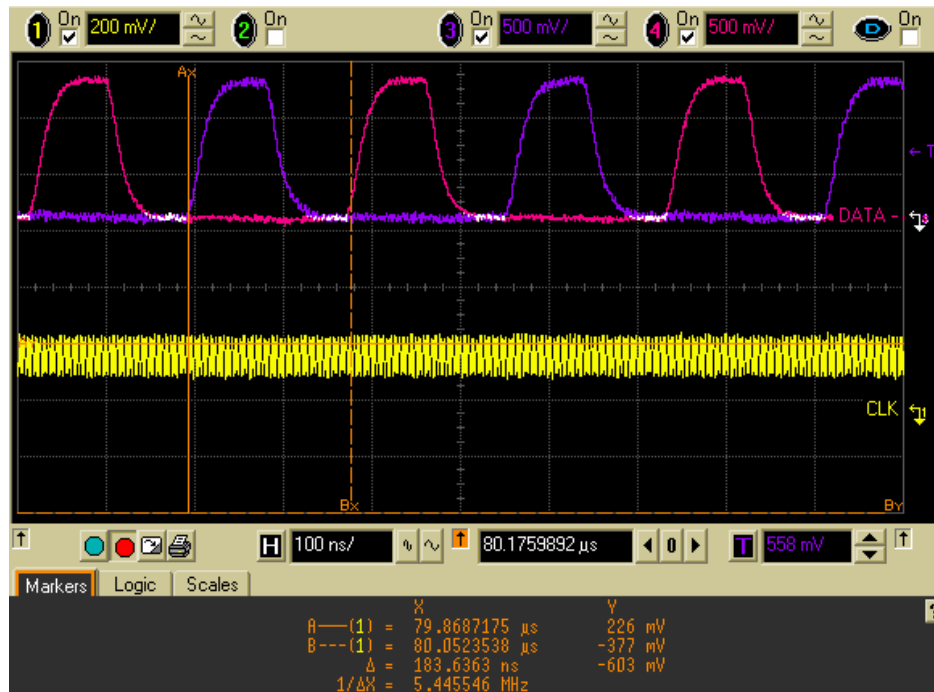

Figure 30: LP clock measurement

- HS clock (HS CLK): HS clock is approximately measured by performing a probing of CLKp or CLKn signals, as shown in Figure 31.

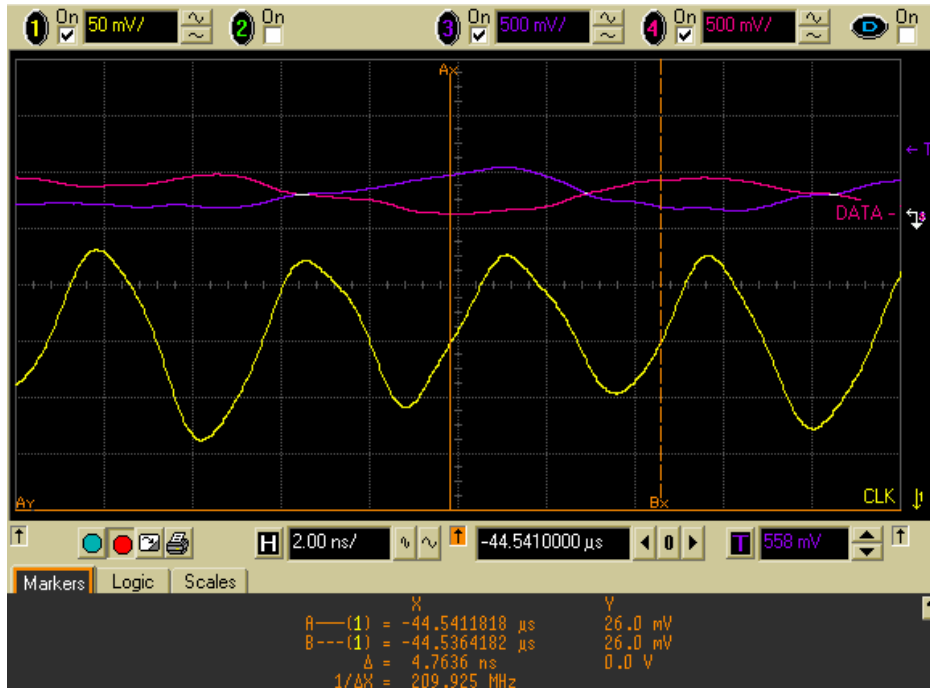

Figure 31: HS measurement

4.2 Basic decoding using an oscilloscope

4.2.1 LP transfer Decoding using an oscilloscope

LP transfer is done using the Escape mode. Escape mode is a special mode of operation for data lanes using low power-states.

Escape mode is supported in forward direction (from host to panel) and optionally in the reverse direction (from panel to host). Data lanes are in escape mode as soon as the escape mode entry procedure is executed (LP-11, LP-10, LP-00, LP-01, LP-00). Once in escape mode, an entry command, as defined in the MIPI DSI standard, is sent by the Tx. The PHY in Escape mode shall apply Spaced-One-Hot bit encoding for asynchronous communication. Therefore, operation of a Data Lane in this mode does not depend on the HS Clock.

Figure 32 shows a complete LPDT procedure.



Figure 32: LP data transmission

Figure 16 shows a LP transfer from panel to host; the escape mode entry is included in the trigger message and the command is a trigger message, ACK.

4.2.2 HS transfer Decoding using an oscilloscope

This section presents basic method to decode a HS packet or verify DSI timing for HS transmission. This approach is not meant to decode a complete frame line, as you will need numerous channels, be able to capture a complete line with a good resolution and be very precise in your sampling. This technique allows you to verify approximately HS timings, synchronization packets, presence of SoT and EoT packets and beginning of a pixel data in a line.

To perform the decoding a 4 channels oscilloscope is necessary, 2 for Dp and Dn and 1 for the clock. The oscilloscope should have a channel subtract mathematical function to determine the differential output.

Figure 33 illustrates a HS transmission, a HSS sync packet done during a vertical line blanking. The figure legend indicates the state and line condition of the Host as define in the MIPI standard. A zoom of the HS packets is provided in Figure 34. The green signal represents Dp minus Dn signal. The sampling of the data is done on peak+ and - of the clock signal as it is a Dual Data Rate (DDR) transmission. Once all bits values are identified, to reconstruct a byte you will need to swap LSB and MSB. LSB of a byte is first (on the left). For example HSS sync packet once sampled is 10000100, see Figure 33. After swapping LSB and MSB, byte becomes 00100001 where the 1st two bits represent the VC, VC0, and the last 6bits are the data type, 100001 HSS sync packet.

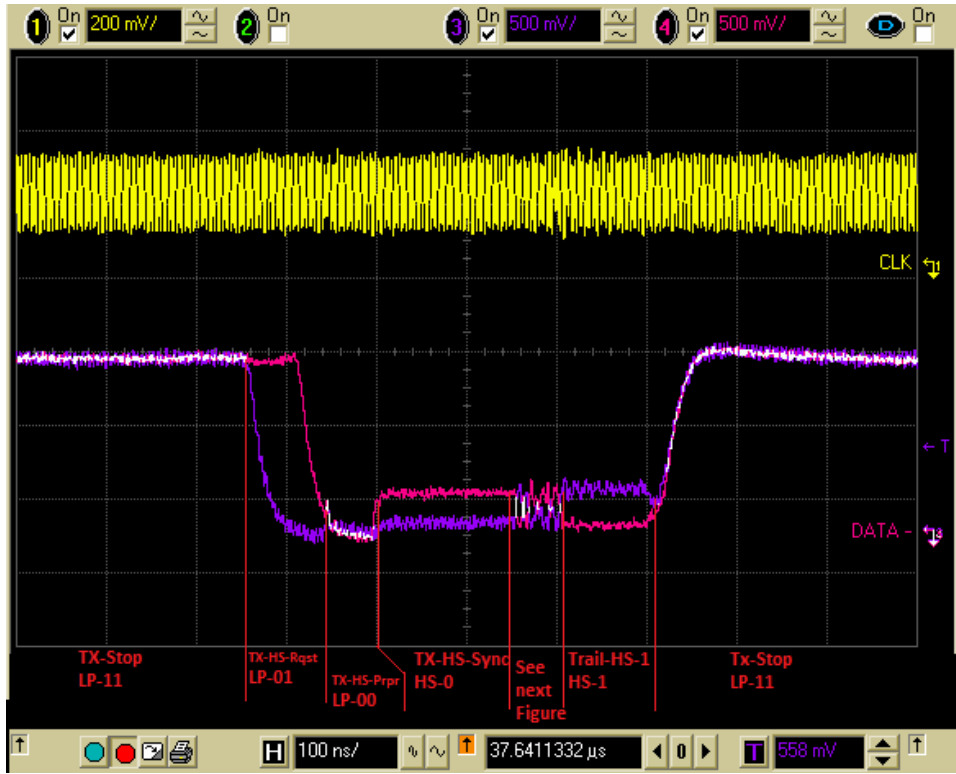

Figure 33: High-Speed Data Transmission

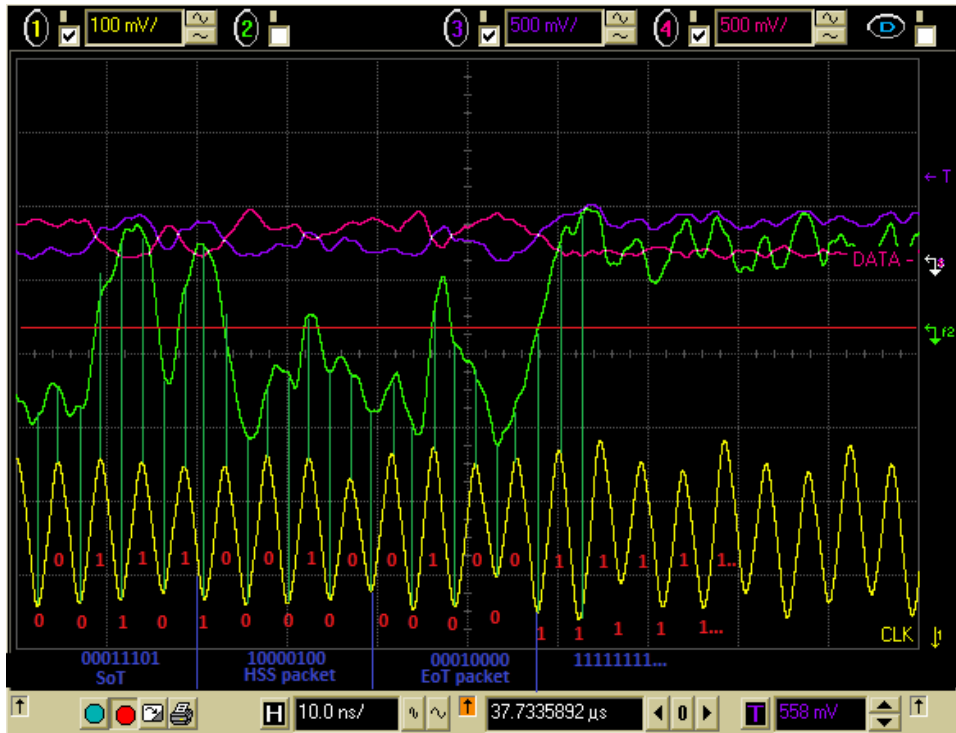

Figure 34: Decoding of HS packet (HSS sync packet)

4.2.3 Determine all clocking and timings of the Display subsystem

2 excel sheets, DSI timings extractor OMAPx.xlsx, are attached to the APN through the paper clip to help user determine all DSS timings and clocking values. User should enter all register settings in the OMAPx DSI configuration sheet and check the result of the timings and clock values in sec or MHz in the Timings and clocks settings.

Appendix A. Display Subsystem configuration

Video mode:

The following configuration was used on OMAP5 Test Evaluation Board (TEB). The registers in setting of the DSI PE, PHY, PLL and DISPC are available in the excel sheet attached in the paper clip.

Command mode:

The configuration used is identical to the blaze with an android release, except it was migrated on an OMAP4 TEB.

References

1. *MIPI Alliance Specification for Display Serial Interface Version 1.02.00 – 28 June 2010*
2. *MIPI Alliance Specification for D-PHY Version 1.02.00 – 28 June 2010*
3. *OMAP543x ES1 Technical Reference Manual version K*

IMPORTANT NOTICE

Texas Instruments Incorporated and its subsidiaries (TI) reserve the right to make corrections, enhancements, improvements and other changes to its semiconductor products and services per JESD46, latest issue, and to discontinue any product or service per JESD48, latest issue. Buyers should obtain the latest relevant information before placing orders and should verify that such information is current and complete. All semiconductor products (also referred to herein as "components") are sold subject to TI's terms and conditions of sale supplied at the time of order acknowledgment.

TI warrants performance of its components to the specifications applicable at the time of sale, in accordance with the warranty in TI's terms and conditions of sale of semiconductor products. Testing and other quality control techniques are used to the extent TI deems necessary to support this warranty. Except where mandated by applicable law, testing of all parameters of each component is not necessarily performed.

TI assumes no liability for applications assistance or the design of Buyers' products. Buyers are responsible for their products and applications using TI components. To minimize the risks associated with Buyers' products and applications, Buyers should provide adequate design and operating safeguards.

TI does not warrant or represent that any license, either express or implied, is granted under any patent right, copyright, mask work right, or other intellectual property right relating to any combination, machine, or process in which TI components or services are used. Information published by TI regarding third-party products or services does not constitute a license to use such products or services or a warranty or endorsement thereof. Use of such information may require a license from a third party under the patents or other intellectual property of the third party, or a license from TI under the patents or other intellectual property of TI.

Reproduction of significant portions of TI information in TI data books or data sheets is permissible only if reproduction is without alteration and is accompanied by all associated warranties, conditions, limitations, and notices. TI is not responsible or liable for such altered documentation. Information of third parties may be subject to additional restrictions.

Resale of TI components or services with statements different from or beyond the parameters stated by TI for that component or service voids all express and any implied warranties for the associated TI component or service and is an unfair and deceptive business practice. TI is not responsible or liable for any such statements.

Buyer acknowledges and agrees that it is solely responsible for compliance with all legal, regulatory and safety-related requirements concerning its products, and any use of TI components in its applications, notwithstanding any applications-related information or support that may be provided by TI. Buyer represents and agrees that it has all the necessary expertise to create and implement safeguards which anticipate dangerous consequences of failures, monitor failures and their consequences, lessen the likelihood of failures that might cause harm and take appropriate remedial actions. Buyer will fully indemnify TI and its representatives against any damages arising out of the use of any TI components in safety-critical applications.

In some cases, TI components may be promoted specifically to facilitate safety-related applications. With such components, TI's goal is to help enable customers to design and create their own end-product solutions that meet applicable functional safety standards and requirements. Nonetheless, such components are subject to these terms.

No TI components are authorized for use in FDA Class III (or similar life-critical medical equipment) unless authorized officers of the parties have executed a special agreement specifically governing such use.

Only those TI components which TI has specifically designated as military grade or "enhanced plastic" are designed and intended for use in military/aerospace applications or environments. Buyer acknowledges and agrees that any military or aerospace use of TI components which have **not** been so designated is solely at the Buyer's risk, and that Buyer is solely responsible for compliance with all legal and regulatory requirements in connection with such use.

TI has specifically designated certain components as meeting ISO/TS16949 requirements, mainly for automotive use. In any case of use of non-designated products, TI will not be responsible for any failure to meet ISO/TS16949.

Products

Audio	www.ti.com/audio
Amplifiers	amplifier.ti.com
Data Converters	dataconverter.ti.com
DLP® Products	www.dlp.com
DSP	dsp.ti.com
Clocks and Timers	www.ti.com/clocks
Interface	interface.ti.com
Logic	logic.ti.com
Power Mgmt	power.ti.com
Microcontrollers	microcontroller.ti.com
RFID	www.ti-rfid.com
OMAP Applications Processors	www.ti.com/omap
Wireless Connectivity	www.ti.com/wirelessconnectivity

Applications

Automotive and Transportation	www.ti.com/automotive
Communications and Telecom	www.ti.com/communications
Computers and Peripherals	www.ti.com/computers
Consumer Electronics	www.ti.com/consumer-apps
Energy and Lighting	www.ti.com/energy
Industrial	www.ti.com/industrial
Medical	www.ti.com/medical
Security	www.ti.com/security
Space, Avionics and Defense	www.ti.com/space-avionics-defense
Video and Imaging	www.ti.com/video

TI E2E Community

e2e.ti.com